

**Test Suite for the
CAE Implementor Forum
Round 4S**

January-May 2019

Release 1.0

March 4, 2019

Contacts

Jochen Boy
PROSTEP AG
Dolivostraße 11
64293 Darmstadt / Germany
jochen.boy@prostep.com

Jean-Marc Crepel
AFNeT
30, Rue de Miromesnil
75008 Paris / France
jean-marc.crepel@afnet.fr

Phil Rosché
ACCR, LLC.
125 King Charles Circle
Summerville, SC 29485 USA
phil.rosche@accr-llc.com

Table of Contents

1	Introduction.....	3
1.1	Functionality tested in this round.....	3
1.2	General testing instructions for this round.....	4
1.3	Testing Schedule	5
1.4	Copyrights on Test Cases.....	5
2	Synthetic Test Case Specifications	6
2.1	Test Case ATS1: beam FEA model using rod elements.....	6
2.2	Test Case ATS2: beam FEA model using bar elements.....	8
2.3	Test Case ATS3: beam FEA model using shell elements.....	11
2.4	Test Case ATS4: beam FEA model using solid elements.....	15

List of Figures

Figure 1:	FEA Validation Properties	3
Figure 2:	Statistics related to Validation Properties.....	4
Figure 3:	CAE-IF Round4S Schedule	5
Figure 4:	ATS1 model overview	7
Figure 5:	ATS2 model overview	10
Figure 6:	ATS3 model overview	13
Figure 7:	ATS4 model overview	16

Document History

Release	Date	Change
1.0	March 4, 2019	First release for R4S kickoff

1 Introduction

This document describes the suite of test cases to be used for the test round R4S of the CAE Implementor Forum (CAE-IF). The CAE-IF is a workgroup in the CAx Implementor Forum (CAx-IF), a joint testing forum, organized and facilitated by AFNeT, PDES, Inc., and the prostep ivip Association. The test rounds of the CAE-IF concentrate primarily on testing the interoperability and compliance of STEP processors based on AP209ed2.

The test rounds in general combine testing of synthetic and production models. Production models will in most cases be provided by the member companies of the organizations ANFeT, PDES, Inc., and prostep ivip Association. When production models are not available from the member companies, “production-like” models will be solicited from the various CAE-IF participants.

This test suite includes synthetic models for testing the following capabilities: export /import Input FEA models for 3D Linear Static Structural Finite Element Analysis using simple models. More complex models, including production models and dynamic analysis, will be introduced later

1.1 Functionality tested in this round

The main objective of the R4S test round is to check the implementation of the Structural FEA validation properties (model level) during an exchange using STEP AP209ed2 translators. It is jointly agreed with the CAE-IF users group (namely EAS working group) to exclude the mass related validation properties from the R4S scope.

Some extensions are defined to test the exchange of metadata such as model title and load case id.

The FEA validation properties are characteristic values of a finite element analysis and are assigned during the export process inside the STEP file with a specific format described in the corresponding “Recommended Practices” document. During the import process, the validation properties are read and compared with the re-calculated values from the STEP file (see Figure 1). They should be used to validate the success of the exchange process.

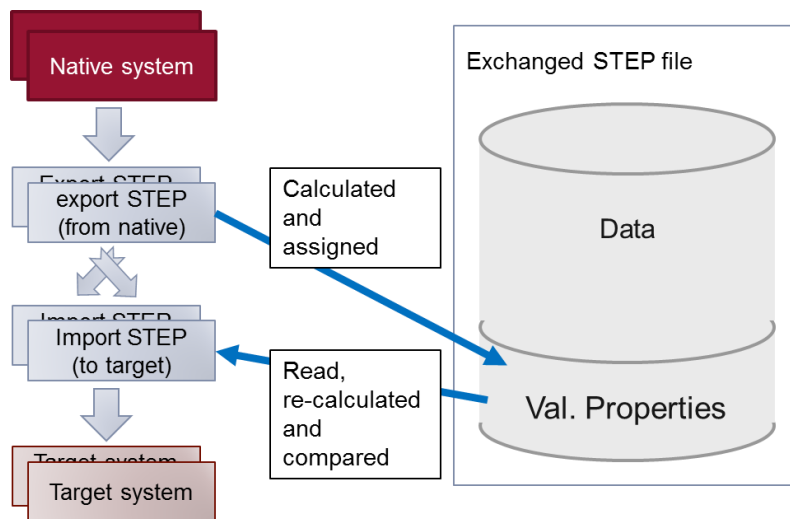

Exchange or LOTAR process according to Rec. Practices

Figure 1: FEA Validation Properties

1.2 General testing instructions for this round

The general procedures for communication of models and statistics are outlined in a separate document, named 'General Testing Instructions'. The document can be retrieved from the CAE Implementor Forum web sites. The latest version is v1.13, dated Sept 29, 2017.

Therefore, the “native statistics” and “target statistics” will be submitted to the CAESAR system according to the regular process described in the 'General Testing Instructions'. Specific statistics will be used to check if the validation properties value included in the native STEP file are equal to the calculated values.

When reporting statistics related to validation properties in the CAESAR system (see Figure 2) :

- The corresponding “native Val Prop. statistics” value should be set to the value assigned in the STEP file if the validation property is implemented in the STEP file, or “na” otherwise;
- The corresponding “target Val Prop. statistics” value should be the value read from the STEP file. It will be compared to the corresponding “target statistics” recalculated value.

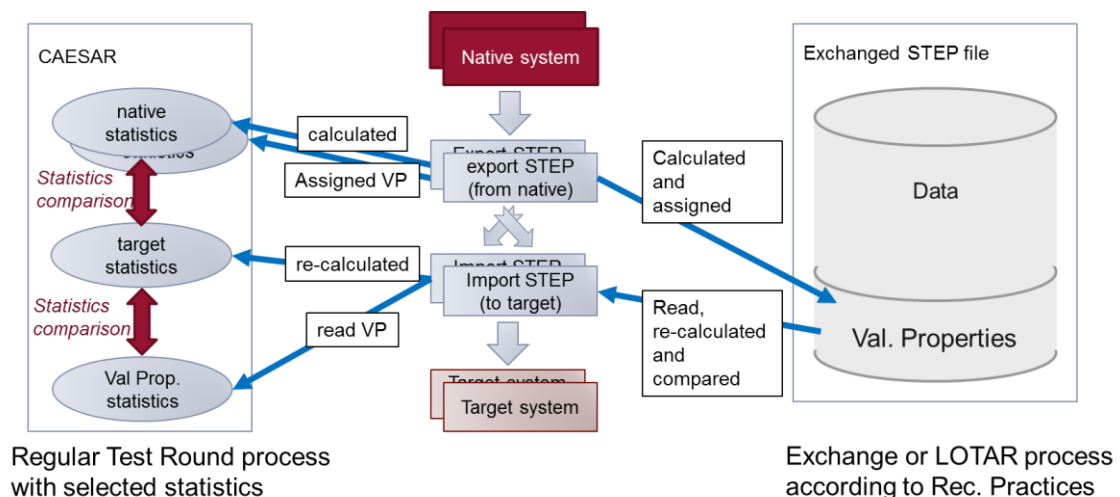

Figure 2: Statistics related to Validation Properties

Key issues should be reported using the BRUTUS system (see 'General Testing Instructions').

Native FEA Model use NASTRAN card descriptions. Documentation of NASTRAN input syntax is available in the “NASTRAN quick reference guide”, which can be download from the MSC homepage at:

- https://simcompanion.mscsoftware.com/infocenter/index?page=content&id=DOC11146&cat=MSC_NASTRAN_DOCUMENTATION_2017&actp=LIST

Original FEA model of each test case is available in the xx.bdf file.

Note: CAE models are generally “unit consistent models”. This means there is no need for data conversion. Participants are requested to keep the original unit system unchanged and to deliver results and statistics using the same unit system as the native models. Nevertheless, **the units’ definition shall be included in the STEP file**, as stated in the recommended practices.

The validation properties shall be assigned in the native STEP file as described in the “Recommended Practices for Structural FEA validation properties” (v0.6 or higher).

1.3 Testing Schedule

The following schedule has been agreed on for Round 4S:

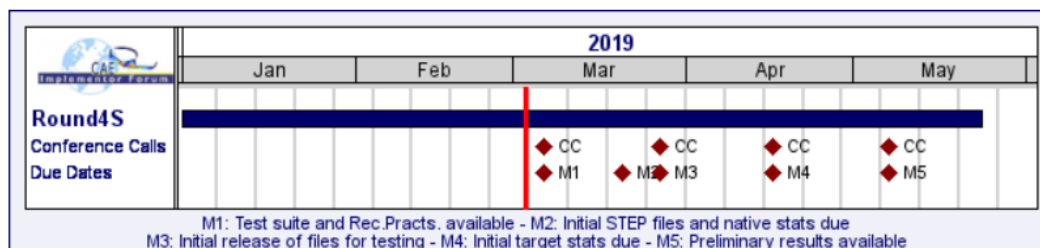

Date	Action
2019-03-06 (Wed)	Test suite and Rec.Practs. available / CAE-IF R4S Kickoff conference call
2019-03-20 (Wed)	Initial STEP files and native stats due
2019-03-27 (Wed)	CAE-IF Round4S Conference Call / Initial release of files for testing
2019-04-16 (Tue)	CAE-IF Round4S Conference Call / Initial target stats due
2019-05-07 (Tue)	CAE-IF Round4S Conference Call / Preliminary results available
2019-05-21 (Tue) - 2019-05-23 (Thu)	CAE-IF Round4S Review Meeting in Toulouse, FR

Figure 3: CAE-IF Round4S Schedule

The CAE-IF Round 4S Technical Workshop will be held by confcall before the PDES, Inc. Spring Offsite meeting and a LOTAR workshop. Therefore, a session will be dedicated to R4S during the Spring Offsite meeting to discuss any feedback. Conference calls and web sessions will also be available for those not attending the meeting to dial in.

The CAE-IF Round4S Review meeting will take place in conjunction with a LOTAR meeting. In addition, conference calls and web sessions will be available.

1.4 Copyrights on Test Cases

1.4.1 CAE-IF

None of the production test cases which were provided by the ANFeT, PDES, Inc. and prostep ivip member companies may be publicly released for any purpose. The test cases can be freely distributed among the CAE-IF members, and can be used for any purposes that are related to CAE-IF testing (i.e. testing, documentation of testing efforts, etc.), as long as a reference to the originating company is made.

The test cases must not be used for any purposes other than CAE-IF testing or outside of ANFeT, PDES, Inc. and prostep ivip. Test cases provided by the LOTAR project for testing of specific capabilities are applicable to the same restrictions and may not be used outside LOTAR or the CAE-IF.

2 Synthetic Test Case Specifications

2.1 Test Case ATS1: beam FEA model using rod elements

All information about this test case can also be viewed in CAESAR on its Information page.

This test case is part of the simple ATSx series models focusing on elementary CAE functionalities. The ATS1 test represents a cantilever beam using “rod” elements only, with one applied lumped force.

2.1.1 Motivation

Within the CAE domain, the following functionalities are in scope of Round 4S:

- Export/import input data of 3D FEA models with
 - 1D elements (rod elements), linear order,
 - Lumped force and fixed boundary conditions
 - Execution control statements
- Assignment of Structural FEA validation properties, typically :
 - Number of nodes, number of elements,
 - 1D size, volume and centroid of the model.
 - Center of gravity
- Metadata exchange :
 - Model title and load case ids

2.1.2 Approach

The approach to be used is described in the latest version of the following documents:

- “Recommended Practices for AP 209 ed2” (at least version 2.0, dated March 30, 2016)
- “AP 209 ed2 Linear Static Structural FEA Handbook” vol.1 - (at least version v 2.2, dated May 16, 2018)
- “AP 209 ed2 Linear Static Structural FEA Handbook” vol.2 - (v 1.0.1, dated Dec 20, 2018).
- “Recommended Practices for Structural FEA validation properties (v 0.6).

For the test round 4S, the assignment of validation properties shall be limited to “model level validation properties” only, excluding mass related validation properties.

These documents can be found either in the public area of the CAx-IF website under “Joint Testing Information” or in the member area of the CAx-IF website under “Information on round 4S of testing”.

The AP 209 schema to be used is a corrected version of the AP 209 ed2 schema, dated Jan 18, 2019, which can be found in the member area of the CAx-IF website, under “**Information on Round 3S** of Testing”.

2.1.3 Testing Instructions

The tests will be performed based on the ATS1m5 NASTRAN model described below. This model has been developed by the LOTAR EAS Working Group, and has been checked during previous pilot studies.

2.1.3.1 Test Model Overview

The ATS1m5 model represents a beam (rectangular prism) idealized using “rod” elements (axial stiffness element, no torsional stiffness), with the following characteristics:

- Isotropic material property
- 1000 lbf axial load in compressive (-x) direction
- Rectangular coordinate system at origin with model at [0, -2, 1]

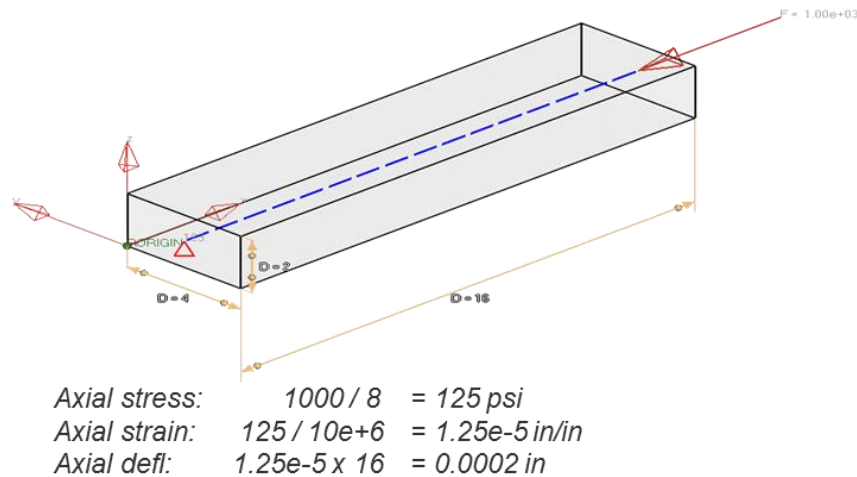

Figure 4: ATS1 model overview

2.1.3.2 Test Model Access

The native NASTRAN files can be downloaded from the member area of the CAx-IF homepages under “General Information – File repository” in the folder “CAE / Round 4S”:

- ATS1m5.bdf (input data)

2.1.3.3 Test Model Configuration

The following functionality shall be included in the test files provided for this round of testing, as far as it has been implemented by the CAE-IF participants and is described in the Recommended Practices:

- Validation Properties – All participants providing STEP files for this test case should include newly defined FEA validation properties as described in the “Recommended Practices for Structural FEA validation properties” (v 0.6).

2.1.4 Statistics

For each STEP file exported or imported for the ATS1 test case, participants must submit the corresponding statistics to CAESAR. To do so, go to the [ATS1 Data Sheet], and either fill in the web form, or upload a comma-delimited file (.csv) with the data as listed below.

Native Statistics

When exporting a STEP file, report what data importing systems should expect to find. For numeric statistics, enter the respective value or 'na' if not supported. For other statistics, select either 'full support' (i.e. test case and Rec. Pracs. definitions are fulfilled), 'limited support' (meaning the implementation does not meet all criteria and issues may be expected on import), or 'na' if not supported.

Target Statistics

When importing a STEP file, report the results found after processing the file as described below. The value should be given in the unit implicitly defined in the native model.

Load Case Selection

Some of the statistics for this test case are load case-related (loadcase_id). When statistics depend on the load case and/or node selection, the item(s) to be considered is indicated in the following table:

Statistic	Case 'A'
Load case identifier	Loadcase #1

Applicable Units and Coordinate system

The model is based on imperial units (in, lbf).

Components of any point (such as Center of Gravity) or vector (such as resultant of applied loads) should be calculated in the basic coordinate system.

Screenshots (optional)

Note that CASEAR allows the addition of multiple screenshots per dataset.

Data Sheet Columns

column name	description
model	The name of the test model, here 'ATS1'
system_n	The system code of the CAE system creating the STEP file
system_t	The system code of the CAE system importing the STEP file. For native stats, select 'stp'
unit	The unit the model is designed in
node_nb	Total number of nodes
validation_nodes_nb	Number of Nodes as received via the validation property capability
element_nb	Total number of elements
validation_elts_nb	Number of Elements as received via the validation property capability
1d_model_size	Cumulated length of 1D elements
validation_1d_size	1D Model Size as received via the validation property capability
1d_elts_centroidx	Center point of the volume defined by all 1D elements in the file
1d_elts_centroidy	
1d_elts_centroidz	
validation_1d_cx	1D elts centroid as received via the validation property capability
validation_1d_cy	
validation_1d_cz	
total_model_vol	Cumulated volume of all (1D, 2D, 3D) elements
validation_model_vol	Total Model Volume as received via the validation property capability
gravx	Position of the Center of Gravity for the model
gravy	
gravz	
validation_gravx	Center of Gravity of the model as received via the validation property capability
validation_gravy	
validation_gravz	
fea_model_title	Title of the FEA model
fea_loadcase_id_a	FEA loadcase identifier - case A
date	The date when the statistics were last updated (will be filled in automatically)
issues	A short statement on issues with the file

2.2 Test Case ATS2: beam FEA model using bar elements

All information about this test case can also be viewed in CAESAR on its Information page.

This test case is part of the simple ATSx series models focusing on elementary CAE functionalities. The ATS2 test represents a cantilever beam using “bar” elements only, with combinations of lumped applied loads.

2.2.1 Motivation

Within the CAE domain, the following functionalities are in scope of Round 4S:

- Export/import input data of 3D FEA models with
 - 1D elements (bar elements), linear order,
 - Lumped force and fixed boundary conditions
 - Execution control statements
- Assignment of Structural FEA validation properties, typically :
 - Number of nodes, of elements, of load cases
 - FEA bounding box
 - 1D size, volume and centroid of the model.
 - Center of gravity

2.2.2 Approach

The approach to be used is described in the latest version of the following documents:

- “Recommended Practices for AP 209 ed2” (at least version 2.0, dated March 30, 2016)
- “AP 209 ed2 Linear Static Structural FEA Handbook” vol.1 - (at least version v 2.2, dated May 16, 2018)
- “AP 209 ed2 Linear Static Structural FEA Handbook” vol. 2 - (v 1.0.1, dated Dec 20, 2018).
- “Recommended Practices for Structural FEA validation properties (v 0.6)
For the test round 4S, the assignment of validation properties shall be limited to “model level validation properties” only, excluding mass related validation properties.

These documents can be found either in the public area of the CAx-IF website under “Joint Testing Information” or in the member area of the CAx-IF website under “Information on round 4S of testing”.

The AP 209 schema to be used is a corrected version of the AP 209 ed2 schema, dated Jan 18, 2019, which can be found in the member area of the CAx-IF website, under “**Information on Round 3S** of Testing”.

2.2.3 Testing Instructions

The tests will be performed based on the ATS2m5 NASTRAN model described below. This model has been developed by the LOTAR EAS Working Group, and has been checked during previous pilot studies.

2.2.3.1 Test Model Overview

The ATS2m5 model represents a beam (rectangular prism) idealized using “bar” elements (axial and bending stiffness element, no torsional stiffness), with the following characteristics:

- Isotropic material property
- 3 load cases:
 1. axial load in compressive (-x) direction
 2. lateral distributed load in bending (-y) direction
 3. combination of 1 + 2

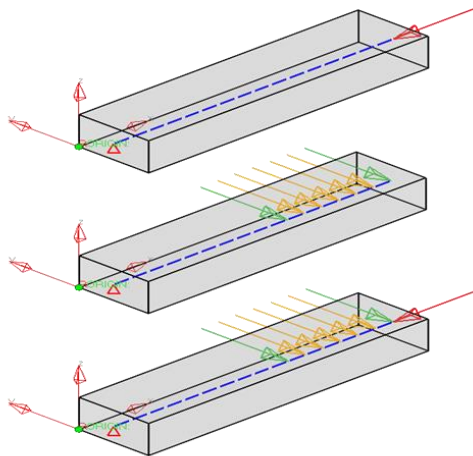

Figure 5: ATS2 model overview

2.2.3.2 Test Model Access.

The native NASTRAN files can be downloaded from the member area of the CAx-IF homepages under “General Information – File repository” in the folder “CAE / Round 4S”:

- ATS2m5.bdf (input data)

2.2.3.3 Test Model Configuration

- See section 2.1.3.3 above.

2.2.4 Statistics

For each STEP file exported or imported for the ATS2 test case, participants must submit the corresponding statistics to CAESAR. To do so, go to the [ATS2 Data Sheet], and either fill in the web form, or upload a comma-delimited file (.csv) with the data as listed below.

Native Statistics

When exporting a STEP file, report what data importing systems should expect to find. For numeric statistics, enter the respective value or 'na' if not supported. For other statistics, select either 'full support' (i.e. test case and Rec. Pracs. definitions are fulfilled), 'limited support' (meaning the implementation does not meet all criteria and issues may be expected on import), or 'na' if not supported.

Target Statistics

When importing a STEP file, report the results found after processing the file as described in the table below. The value should be given in the unit implicitly defined in the native model.

Applicable Units and Coordinate system

The model is based on imperial units (in, lbf).

Components of any point (such as Center of Gravity) or vector (such as resultant of applied loads) should be calculated in the basic coordinate system.

Screenshots(optional)

Note that CAESAR allows the addition of multiple screenshots per dataset.

Data Sheet Columns

column name	description
model	The name of the test model, here 'ATS2'
system_n	The system code of the CAE system creating the STEP file
system_t	The system code of the CAE system importing the STEP file. For native stats, select 'stp'
unit	The unit the model is designed in
node_nb	Total number of nodes
validation_nodes_nb	Number of Nodes as received via the validation property capability
element_nb	Total number of elements
validation_elts_nb	Number of Elements as received via the validation property capability
fea_bbox_minx	The (min X, min Y, min Z) corner point of the Bounding Box relative to the grid points
fea_bbox_miny	
fea_bbox_minz	
validation_fea_bb_minx	FEA BBox Min Point as received via the validation property capability
validation_fea_bb_miny	
validation_fea_bb_minz	
fea_bbox_maxx	The (max X, max Y, max Z) corner point of the Bounding Box relative to the grid points
fea_bbox_maxy	
fea_bbox_maxz	
validation_fea_bb_maxx	FEA BBox Max Point as received via the validation property capability
validation_fea_bb_maxy	
validation_fea_bb_maxz	
1d_model_size	Cumulated length of 1D elements
validation_1d_size	1D Model Size as received via the validation property capability
1d_elts_centroidx	Center point of the volume defined by all 1D elements in the file
1d_elts_centroidy	
1d_elts_centroidz	
validation_1d_cx	1D elts centroid as received via the validation property capability
validation_1d_cy	
validation_1d_cz	
total_model_vol	Cumulated volume of all (1D, 2D, 3D) elements
validation_model_vol	Total Model Volume as received via the validation property capability
gravx	Position of the Center of Gravity for the model
gravy	
gravz	
validation_gravx	Center of Gravity of the model as received via the validation property capability
validation_gravy	
validation_gravz	
loadcases_nb	Number of different load cases
validation_loads_nb	Number of Load Cases as received via the validation property capability
date	The date when the statistics were last updated (will be filled in automatically)
issues	A short statement on issues with the file

2.3 Test Case ATS3: beam FEA model using shell elements

All information about this test case can also be viewed in CAESAR on its Information page.

This test case is part of the simple ATSx series models focusing on elementary CAE functionalities. The ATS3 test represents a cantilever beam using “shell” elements only, with additional boundary conditions and combinations of lumped and distributed (pressure) applied loads.

2.3.1 Motivation

Within the CAE domain, the following functionalities are in scope of Round 4S:

- Export/import input data of 3D FEA models with
 - 2D elements (shell elements),
 - Lumped and distributed forces, with fixed boundary conditions
 - Execution control statements
- Assignment of Structural FEA validation properties, typically :
 - Number of nodes, of elements, of load cases
 - FEA bounding box
 - 2D size, volume and centroid of the model.
 - Center of gravity
- Metadata exchange :
 - Model title and load case ids

2.3.2 Approach

The approach to be used is described in the latest version of the following documents:

- “Recommended Practices for AP 209 ed2” (at least version 2.0, dated March 30, 2016)
- “AP 209 ed2 Linear Static Structural FEA Handbook” vol.1 - (at least version v 2.2, dated May 16, 2018)
- “AP 209 ed2 Linear Static Structural FEA Handbook” vol. 2 - (v 1.0.1, dated Dec 20, 2018).
- “Recommended Practices for Structural FEA validation properties (v 0.6)
For the test round 4S, the assignment of validation properties shall be limited to “model level validation properties” only, excluding mass related validation properties.

These documents can be found either in the public area of the CAx-IF website under “Joint Testing Information” or in the member area of the CAx-IF website under “Information on round 4S of testing”.

The AP 209 schema to be used is a corrected version of the AP 209 ed2 schema, dated Jan 18, 2019, which can be found in the member area of the CAx-IF website, under “**Information on Round 3S** of Testing”.

2.3.3 Testing Instructions

The tests will be performed based on the AT3m5 NASTRAN model described below. This model has been developed by the LOTAR EAS Working Group, and has been checked during previous pilot studies.

2.3.3.1 Test Model Overview

The AT3m5 model represents a beam (rectangular prism) idealized using “shell” elements (membrane and bending stiffness element), with the following characteristics:

- Isotropic material property
- 4 load cases:
 1. axial distributed load in compressive (-x) direction
 2. lateral distributed load in bending (-y) direction
 3. combination of 1 + 2
 4. normal distributed load in bending (-z) direction

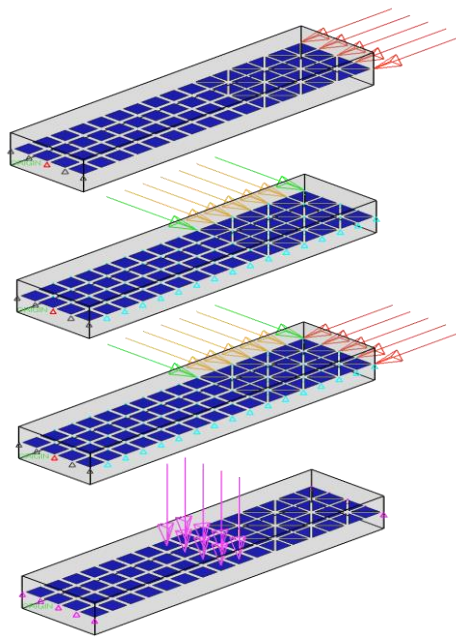

Figure 6: ATS3 model overview

2.3.3.2 Test Model Access.

The native NASTRAN files can be downloaded from the member area of the CAx-IF homepages under “General Information – File repository” in the folder “CAE / Round 4S”:

- ATS3m5.bdf (input data)

2.3.3.3 Test Model Configuration

- See section 2.1.3.3 above.

2.3.4 Statistics

For each STEP file exported or imported for the ATS3 test case, participants must submit the corresponding statistics to CAESAR. To do so, go to the [ATS3 Data Sheet], and either fill in the web form, or upload a comma-delimited file (.csv) with the data as listed below.

Native Statistics

When exporting a STEP file, report what data importing systems should expect to find. For numeric statistics, enter the respective value or 'na' if not supported. For other statistics, select either 'full support' (i.e. test case and Rec. Pracs. definitions are fulfilled), 'limited support' (meaning the implementation does not meet all criteria and issues may be expected on import), or 'na' if not supported.

Target Statistics

When importing a STEP file, report the results found after processing the file as described in the table below. The value should be given in the unit implicitly defined in the native model.

Load Cases Selection

Some of the statistics for this test case are load case-related (load case id). When statistics depend on the load case and/or node selection, the item(s) to be considered is indicated in the following table:

Statistic	Case 'A'	Case 'B'
Loadcase id	Loadcase #3	Loadcase #4

Applicable Units and Coordinate system

The model is based on imperial units (in, lbf).

Components of any point (such as Center of Gravity) or vector (such as resultant of applied loads) should be calculated in the basic coordinate system.

Screenshots(optional)

Note that CASEAR allows the addition of multiple screenshots per dataset.

Data Sheet Columns

column name	description
model	The name of the test model, here 'ATS3'
system_n	The system code of the CAE system creating the STEP file
system_t	The system code of the CAE system importing the STEP file. For native stats, select 'stp'
unit	The unit the model is designed in
node_nb	Total number of nodes
validation_nodes_nb	Number of Nodes as received via the validation property capability
element_nb	Total number of elements
validation_elts_nb	Number of Elements as received via the validation property capability
fea_bbox_minx	The (min X, min Y, min Z) corner point of the Bounding Box relative to the grid points
fea_bbox_miny	
fea_bbox_minz	
validation_fea_bb_minx	FEA BBox Min Point as received via the validation property capability
validation_fea_bb_miny	
validation_fea_bb_minz	
fea_bbox_maxx	The (max X, max Y, max Z) corner point of the Bounding Box relative to the grid points
fea_bbox_maxy	
fea_bbox_maxz	
validation_fea_bb_maxx	FEA BBox Max Point as received via the validation property capability
validation_fea_bb_maxy	
validation_fea_bb_maxz	
2d_model_size	Cumulated surface area of 2D elements
validation_2d_size	2D Model Size as received via the validation property capability
2d_elts_centroidx	Center point of the volume defined by all 2D elements in the file
2d_elts_centroidy	
2d_elts_centroidz	
validation_2d_cx	2D elts centroid as received via the validation property capability
validation_2d_cy	
validation_2d_cz	
total_model_vol	Cumulated volume of all (1D, 2D, 3D) elements
validation_model_vol	Total Model Volume as received via the validation property capability
gravx	Position of the Center of Gravity for the model
gravy	
gravz	
validation_gravx	Center of Gravity of the model as received via the validation property capability
validation_gravy	
validation_gravz	
loadcases_nb	Number of different load cases
validation_loads_nb	Number of Load Cases as received via the validation property capability
fea_model_title	Title of the FEA model
fea_loadcase_id_a	FEA loadcase identifier - case A
fea_loadcase_id_b	FEA loadcase identifier - case B
date	The date when the statistics were last updated (will be filled in automatically)
issues	A short statement on issues with the file

2.4 Test Case ATS4: beam FEA model using solid elements

All information about this test case can also be viewed in CAESAR on its Information page.

This test case is part of the simple ATsx series models focusing on elementary CAE functionalities. The ATS4 test represents a cantilever beam using different “solid” elements, with combinations of lumped applied forces.

2.4.1 Motivation

Within the CAE domain, the following functionalities are in scope of Round 4S:

- Export/import input data of 3D FEA models with
 - 3D elements (solid elements), linear order,
 - Combination of lumped forces and fixed boundary conditions
 - Execution control statements
- Assignment of Structural FEA validation properties, typically :
 - Number of nodes, of elements, of load cases
 - FEA bounding box
 - 3D size, volume and centroid of the model.
 - Center of gravity

2.4.2 Approach

The approach to be used is described in the latest version of the following documents:

- “Recommended Practices for AP 209 ed2” (at least version 2.0, dated March 30, 2016)
- “AP 209 ed2 Linear Static Structural FEA Handbook” vol.1 - (at least version v 2.2, dated May 16, 2018)
- “AP 209 ed2 Linear Static Structural FEA Handbook” vol. 2 - (v 1.0.1, dated Dec 20, 2018).
- “Recommended Practices for Structural FEA validation properties (v 0.6)
For the test round 4S, the assignment of validation properties shall be limited to “model level validation properties” only, excluding mass related validation properties.

These documents can be found either in the public area of the CAx-IF website under “Joint Testing Information” or in the member area of the CAx-IF website under “Information on round 4S of testing”.

The AP 209 schema to be used is a corrected version of the AP 209 ed2 schema, dated Jan 18, 2019, which can be found in the member area of the CAx-IF website, under “**Information on Round 3S** of Testing”.

2.4.3 Testing Instructions

The tests will be performed based on the ATS4m5 NASTRAN model described below. This model has been developed by the LOTAR EAS Working Group, and has been checked during previous pilot studies.

2.4.3.1 Test Model Overview

The ATS4m5 model represents a beam (rectangular prism) idealized using “solid” elements (mix of 4-noded tetrahedral, 6-noded pentahedral and 8-noded hexahedral elements), with the following characteristics:

- Isotropic material property
- 3 load cases:

1. axial distributed load in compressive (-x) direction
2. lateral distributed load in bending (-y) direction
3. combination of 1 + 2

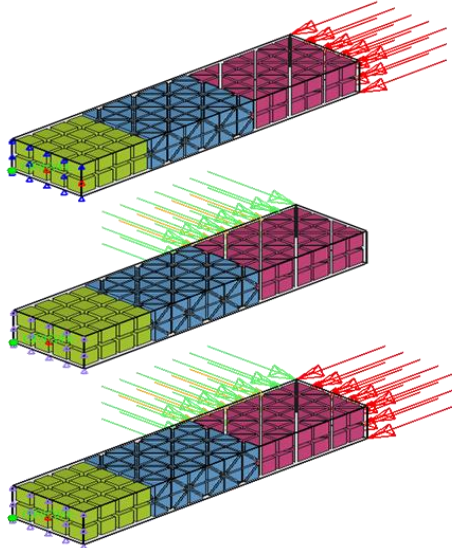

Figure 7: ATS4 model overview

2.4.3.2 Test Model Access.

The native NASTRAN files can be downloaded from the member area of the CAx-IF homepages under “General Information – File repository” in the folder “CAE / Round 4S”:

- ATS4m5.bdf (input data)

2.4.3.3 Test Model Configuration

- See section 2.1.3.3 above.

2.4.4 Statistics

For each STEP file exported or imported for the ATS4 test case, participants must submit the corresponding statistics. To do so, go to the [ATS4 Data Sheet], and either fill in the web form, or upload a comma-delimited file (.csv) with the data as listed below.

Native Statistics

When exporting a STEP file, report what data importing systems should expect to find. For numeric statistics, enter the respective value or 'na' if not supported. For other statistics, select either 'full support' (i.e. test case and Rec. Pracs. definitions are fulfilled), 'limited support' (meaning the implementation does not meet all criteria and issues may be expected on import), or 'na' if not supported.

Target Statistics

When importing a file, report the results found after processing the file as described in the table below. The value should be given in the unit implicitly defined in the native model.

Applicable Units and Coordinate system

The model is based on imperial units (in, lbf).

Components of any point (such as Center of Gravity) or vector (such as resultant of applied loads) should be calculated in the basic coordinate system.

Screenshots(optional)

Note that CASEAR allows the addition of multiple screenshots per dataset.

Data Sheet Columns

column name	description
model	The name of the test model, here 'ATS4'
system_n	The system code of the CAE system creating the STEP file
system_t	The system code of the CAE system importing the STEP file. For native stats, select 'stp'
unit	The unit the model is designed in
node_nb	Total number of nodes
validation_nodes_nb	Number of Nodes as received via the validation property capability
element_nb	Total number of elements
validation_elts_nb	Number of Elements as received via the validation property capability
fea_bbox_minx	The (min X, min Y, min Z) corner point of the Bounding Box relative to the grid points
fea_bbox_miny	
fea_bbox_minz	
validation_fea_bb_minx	FEA BBox Min Point as received via the validation property capability
validation_fea_bb_miny	
validation_fea_bb_minz	
fea_bbox_maxx	The (max X, max Y, max Z) corner point of the Bounding Box relative to the grid points
fea_bbox_maxy	
fea_bbox_maxz	
validation_fea_bb_maxx	FEA BBox Max Point as received via the validation property capability
validation_fea_bb_maxy	
validation_fea_bb_maxz	
3d_model_size	Cumulated volume of 3D elements
validation_3d_size	3D Model Size as received via the validation property capability
3d_elts_centroidx	Center point of the volume defined by all 3D elements in the file
3d_elts_centroidy	
3d_elts_centroidz	
validation_3d_cx	3D elts centroid as received via the validation property capability
validation_3d_cy	
validation_3d_cz	
total_model_vol	Cumulated volume of all (1D, 2D, 3D) elements
validation_model_vol	Total Model Volume as received via the validation property capability
gravx	Position of the Center of Gravity for the model
gravy	
gravz	
validation_gravx	Center of Gravity of the model as received via the validation property capability
validation_gravy	
validation_gravz	
loadcases_nb	Number of different load cases
validation_loads_nb	Number of Load Cases as received via the validation property capability
date	The date when the statistics were last updated (will be filled in automatically)
issues	A short statement on issues with the file